

Uniclass Pr_35_57_11_26	
CI/SfB (71.3)	X

April 2020



**SUPPLY & FIT
SERVICE
NOW AVAILABLE**



ENTRANCE MATTING SYSTEMS

APRIL 2020

Simple pricing | Free site measures | Quick turnaround available



ENTRANCE MATTING SYSTEMS

CASE STUDIES

Residential Development, Glasgow



RESIDENTIAL

Offices, London



OFFICE

HM Navy Dockyard, Portsmouth



GOVERNMENT & MOD

NHS A&E, Dorset



HEALTHCARE

Secondary School, Nottingham



EDUCATION

Motorway Services, Toddington



TRANSPORT

The Mailbox, Birmingham



RETAIL

Cinema, London



HOTEL & LEISURE

CONTENTS

INTRODUCTION

Case Studies	0
Why Quantum Flooring Solutions?	2
Why is Entrance Matting important?	3
How to choose the correct Entrance Matting	4-5

PRODUCTS

Primary Matting

Q-Guard High Traffic Matting	6-7
Q-Grid Matting	8-9
Q-Connect Matting	10-11
Q-Fibre Matting	12-13
Q-Tile 50 cm Entrance Matting Tile	14-15
Q-Click 25 cm Entrance Matting Tile	16-17

Secondary Matting

Secondary Matting	18-19
-------------------------	-------

Miscellaneous

Matting Accessories	20
How much matting is required?	21
Installation	21
Cleaning & Maintenance	21
TopClip Flooring Transitions	22
Colour Range	23

SERVICES

Site Measure Service	23
Supply & Fit Service	23
RIBA CPD	24
RIBA Road Show – Lunch & Learn	24

WHY QUANTUM FLOORING SOLUTIONS?

It is a name you can trust. Quantum Flooring Solutions is a leader in the flooring accessories' market and offers a complete range of products that help to keep entrances safe and clean (Matting), give a clean finish to floors at wall junctions (Skirtings and Cappings), cover for neat joints in floorcoverings (Trims, Edgings and Transitions) and make stairs safe (Stair Nosings and Edgings).

Accredited:

ISO14001

A commitment to environmental protection.



ISO9001

A commitment to continually improve the manufacturing process.



Simple specification:

bimstore

The first flooring accessories manufacturer to have BIM models.



NBS Plus

All products can be specified through NBS Plus.



Member of:

CFA

Membership of the only trade body representing the contract flooring market.



And offers:

A 10 year warranty

Providing peace of mind for your projects, subject to project application and correct maintenance.



Free RIBA CPDs

Learn how to correctly specify Stair Nosings and Entrance Matting with a market leading CPD.



WHY IS ENTRANCE MATTING IMPORTANT?

REDUCE THE RISK OF SLIPS, TRIPS AND FALLS



HSE

Every 5 minutes there is a slip or fall in a non-domestic building leading to **300,000 hospital visits** each year.

£14,000 is the average cost of a claim from a slip or a trip.

90% of slip accidents happen on **wet floors**.

REMOVE DIRT & MOISTURE

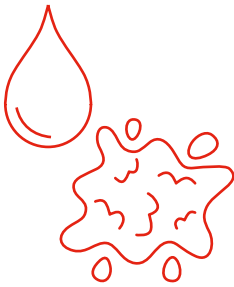

BS 7953 Part 5.1

The entrance flooring system should scrape, wipe and retain soil, making contact with both feet of people entering the building and, in the case of wheeled traffic, with the circumference of the wheels.

REDUCE MAINTENANCE COSTS

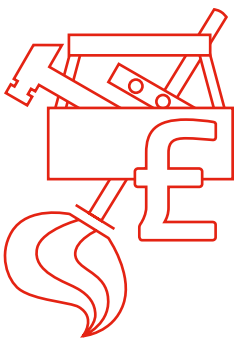

BS 7953 Part 5.1

The repair and maintenance costs of a typical floor covering over its lifespan could be nine times the cost of the original investment. A well designed entrance flooring system will prevent dirt and moisture from being tracked in and thereby prolong the life of interior flooring and reduce cleaning, repair and overall maintenance costs.

HOW TO CHOOSE THE CORRECT ENTRANCE MATTING

1) What is the volume of traffic?

How often will the entrance mat be crossed on the average day?



Light = less than 500 people per day
(examples: offices & residential)



Medium = 500 to 5000 people per day
(examples: schools & hospitals)



Heavy = more than 5000 people per day
(examples: railway stations & airports)

2) What is the type of traffic?

What types of traffic will cross the entrance mat?



Light = up to 200 kg
(examples: foot / shopping trolley / wheelchair)



Medium = Up to 500 kg
(examples: pallet truck / retail cage)



Heavy = Up to and above 1 ton
(examples: forklift truck / cherry picker)

3) What performance is required from the matting?



Dirt Removal = high



Dirt Removal = medium



Moisture Removal = high



Moisture Removal = medium

4) What type of construction is required?

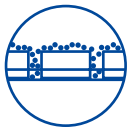

Open

Open matting incorporates a gap between each matting profile. This allows for moisture and dirt to fall through and be collected in the matwell. The mat should be occasionally removed and the matwell cleaned.



Closed

Closed matting keeps all moisture and dirt on the surface of the mat, this can be removed by regular cleaning.

5) What area is the matting going in?



External Matting



Internal Primary Matting



Internal Secondary Matting

Q-GUARD HIGH TRAFFIC MATTING

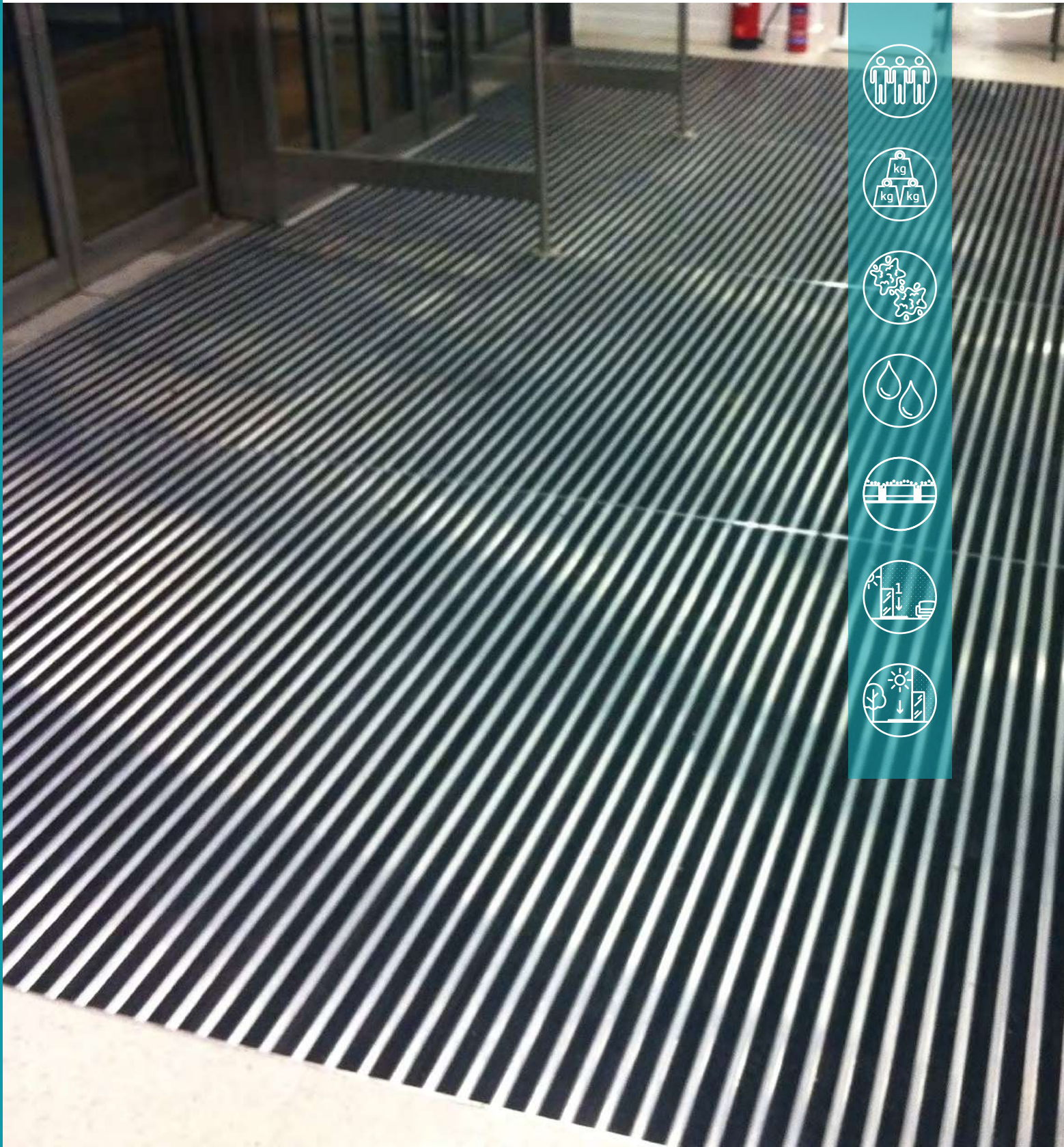

Q-GUARD HIGH TRAFFIC MATTING



For over thirty years this design has provided the ideal matting solution for busy entrance ways in public buildings. It is extremely durable and will withstand the toughest of wear conditions with minimum maintenance required. Acknowledged by key operators in building design and maintenance to have a proven track record, Q-Guard is installed in major Shopping Centres, Retail Stores, Hospitals, Universities and all manner of commercial sites throughout the UK. Comprising alternating high grade aluminium scraper rails and nylon reinforced flexible rubber wiper strips, Q-Guard is double-sided for extended product life.

- » 12 & 17 mm options
- » Extremely durable
- » Highly effective
- » Easily cleaned
- » Non tracking
- » Quick drying
- » Double sided
- » 100% recyclable

HOW TO ORDER

- » **PRODUCT RANGE:** Q-GUARD
- » **THICKNESSES AVAILABLE:** 12 mm & 17 mm
- » **CONSTRUCTION:** CLOSED
- » **LOCATION:** INTERNAL or EXTERNAL
- » **FIRE RATED:** YES or NO
- » **COLOUR:** CHOOSE FROM COLOUR RANGE

PRODUCT INFORMATION

- » **GUARANTEE:** 10 YEARS
- » **VOLUME OF TRAFFIC:** HEAVY
- » **TYPE OF TRAFFIC:** HEAVY
- » **SUGGESTED APPLICATIONS:**
TRAIN STATIONS / SHOPPING CENTRES
- » **USAGE:** PRIMARY BARRIER MATTING

COLOUR RANGE

INTERNAL – Rubber Nylon



EXTERNAL – Rubber Rib



Other colours available on request.

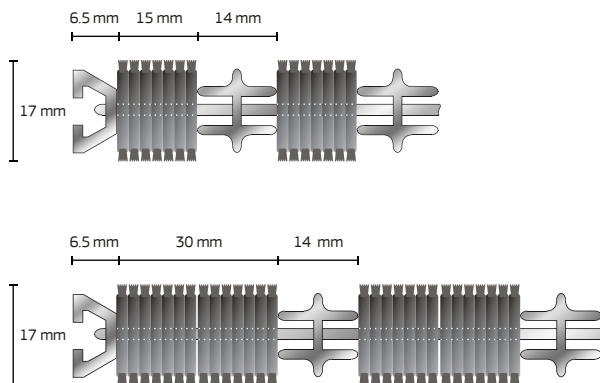

SPECIFICATION STATEMENT

NBS Specification :

N10 GENERAL FIXTURES / FURNISHINGS / EQUIPMENT
300 ENTRANCE MATTING / 40 MISCELLANEOUS FITTINGS

Manufacturer:

Quantum Flooring, QPSL, Salmon Fields, Royton, Oldham, OL2 6JG
Tel: 0161 627 4222 Email: info@quantumflooring.co.uk
Website: www.quantumflooring.co.uk

Reference: Q-Guard High Traffic Matting

Construction (select as required): Closed construction, Single or Double wipers, 12mm or 17mm height

Linking strip material: Aluminium

Wiper colour: See colour range

Fixing: Recessed in matwell or surface-mounted with ramping frame

Q-GRID MATTING



-
-
-
-
-
-
-



Q-GRID MATTING



Q-Grid has an arch form heavy gauge aluminium chassis capable of withstanding medium traffic in the most demanding of applications. Where 24hr exposure to maintenance and access equipment, wheelchairs, shopping trolleys and the like is expected, Q-Grid can be specified with confidence.

42 mm wide wiper strips provide optimum contact area for absorbency and soil collection. There is a wide variety of wiper strip options to suit almost any application.

HOW TO ORDER

- » **PRODUCT RANGE:** Q-GRID MATTING
- » **THICKNESSES AVAILABLE:** 15 mm & 19 mm
- » **CONSTRUCTION:** CLOSED
- » **LOCATION:** INTERNAL or EXTERNAL
- » **COLOUR:** CHOOSE FROM COLOUR RANGE

PRODUCT INFORMATION

- » **GUARANTEE:** 10 YEARS
- » **VOLUME OF TRAFFIC:** MEDIUM
- » **TYPE OF TRAFFIC:** MEDIUM
- » **SUGGESTED APPLICATIONS:**
SCHOOLS / HOSPITALS
- » **USAGE:** PRIMARY BARRIER MATTING

COLOUR RANGE

INTERNAL – Tufted Nylon

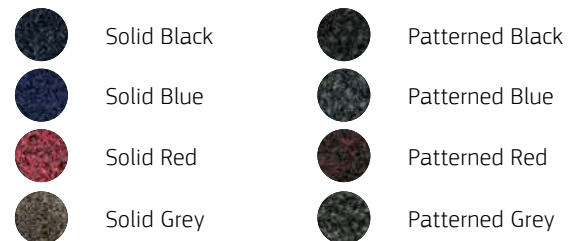

EXTERNAL – Rubber Rib.



Other colours available on request.

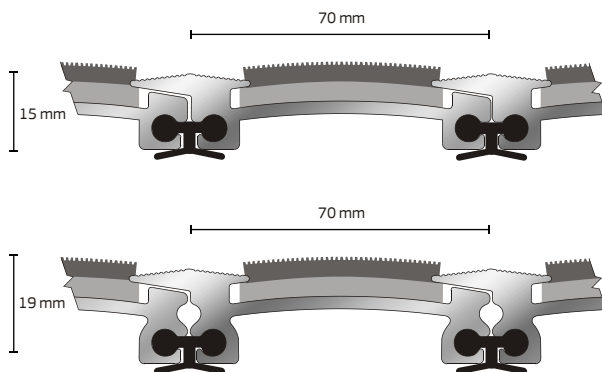

SPECIFICATION STATEMENT

NBS Specification :

N10 GENERAL FIXTURES / FURNISHINGS / EQUIPMENT
300 ENTRANCE MATTING / 40 MISCELLANEOUS FITTINGS

Manufacturer:

Quantum Flooring, QPSL, Salmon Fields, Royton, Oldham, OL2 6JG
Tel: 0161 627 4222 Email: info@quantumflooring.co.uk
Website: www.quantumflooring.co.uk

Reference: Q-Grid Matting

Construction (select as required): Closed construction, Single or Double wipers, 15 mm or 19 mm height

Linking strip material: Aluminium

Wiper colour: See colour range

Fixing:

Recessed in matwell or surface-mounted with ramping frame

Q-CONNECT MATTING



Q-CONNECT MATTING



Q-Connect is a hard wearing primary entrance mat with exceptional performance. The closed construction ensures that all debris is captured by the mat surface for a convenient cleaning operation.

Suitable for both foot and trolley traffic, the design features deep profile aluminium scraper treads for maximum effect, the matting is assembled by means of a PVC hinge which features an integral damper strip. There is a wide variety of wiper strip options to suit almost any application.

HOW TO ORDER

- » **PRODUCT RANGE:** Q-CONNECT
- » **THICKNESSES AVAILABLE:** 17 mm & 22 mm
- » **CONSTRUCTION:** CLOSED
- » **LOCATION:** INTERNAL or EXTERNAL
- » **COLOUR:** CHOOSE FROM COLOUR RANGE

PRODUCT INFORMATION

- » **GUARANTEE:** 10 YEARS
- » **VOLUME OF TRAFFIC:** MEDIUM
- » **TYPE OF TRAFFIC:** LIGHT
- » **SUGGESTED APPLICATIONS:**
OFFICES / APARTMENT BLOCKS
- » **USAGE:** PRIMARY BARRIER MATTING

COLOUR RANGE

INTERNAL – Tufted Nylon

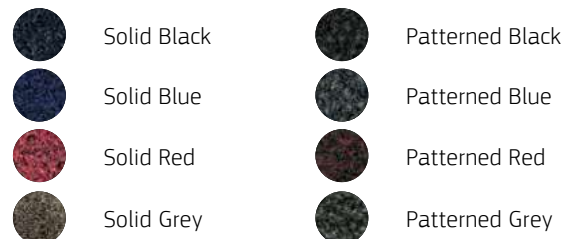

EXTERNAL – Rubber Rib.



Other colours available on request.

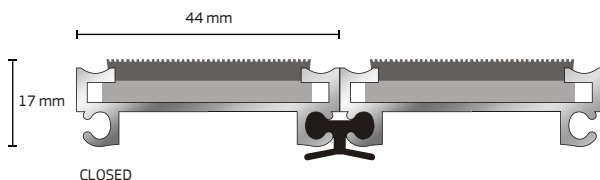

SPECIFICATION STATEMENT

NBS Specification :

N10 GENERAL FIXTURES / FURNISHINGS / EQUIPMENT
300 ENTRANCE MATTING / 40 MISCELLANEOUS FITTINGS

Manufacturer:

Quantum Flooring, QPSL, Salmon Fields, Royton, Oldham, OL2 6JG
Tel: 0161 627 4222 Email: info@quantumflooring.co.uk
Website: www.quantumflooring.co.uk

Reference: Q-Connect Matting

Construction (select as required): Closed construction, Single or Double wipers, 17 mm or 22 mm height

Linking strip material: Aluminium

Wiper colour: See colour range

Fixing:

Recessed in matwell or surface-mounted with ramping frame

Q-FIBRE MATTING



Q-FIBRE MATTING



Q-Fibre Connect is a hard wearing primary entrance mat with exceptional performance. The open construction has the ability to retain its elegant appearance whilst handling high volume traffic due to the collection grid layout that channels the debris down beneath the contact surface. The matting can be rolled up for cleaning and maintenance of the recess.

Suitable for both foot and trolley traffic, the design features deep profile aluminium scraper treads for maximum effect, the matting is assembled by means of a PVC hinge which features an integral damper strip. There is a wide variety of wiper strip options to suit almost any application.

HOW TO ORDER

- » **PRODUCT RANGE:** Q-FIBRE
- » **THICKNESSES AVAILABLE:** 17 mm & 22 mm
- » **CONSTRUCTION:** OPEN
- » **LOCATION:** INTERNAL
- » **COLOUR:** CHOOSE FROM COLOUR RANGE

PRODUCT INFORMATION

- » **GUARANTEE:** 10 YEARS
- » **VOLUME OF TRAFFIC:** MEDIUM
- » **TYPE OF TRAFFIC:** LIGHT
- » **SUGGESTED APPLICATIONS:**
OFFICES / APARTMENT BLOCKS
- » **USAGE:** PRIMARY BARRIER MATTING

COLOUR RANGE

INTERNAL – Needle-punch fibre bonded rib



Other colours available on request.

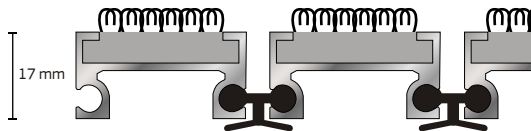

SPECIFICATION STATEMENT

NBS Specification :

N10 GENERAL FIXTURES / FURNISHINGS / EQUIPMENT
300 ENTRANCE MATTING / 40 MISCELLANEOUS FITTINGS

Manufacturer:

Quantum Flooring, QPSL, Salmon Fields, Royton, Oldham, OL2 6JG
Tel: 0161 627 4222 Email: info@quantumflooring.co.uk
Website: www.quantumflooring.co.uk

Reference: Q-Fibre Matting

Construction (select as required): Open construction,
Single or Double wipers, 17 mm or 22 mm height

Linking strip material: Aluminium

Wiper colour: See colour range

Fixing:

Recessed in matwell or surface-mounted with ramping frame

Q-TILE 50 CM ENTRANCE MATTING TILE

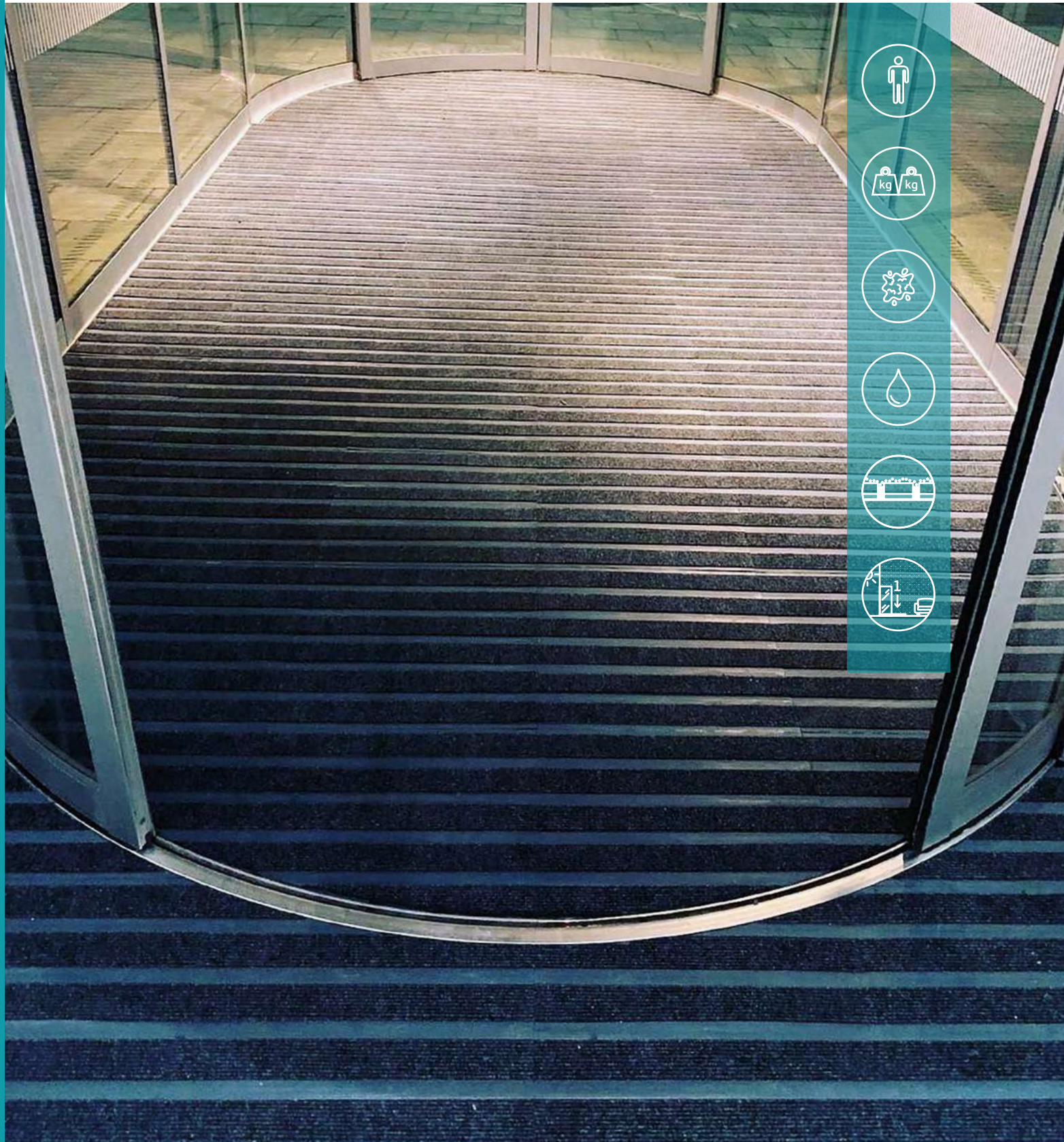

Q-TILE 50CM ENTRANCE MATTING TILE



Provides a cost-effective high specification solution for all recessed matting applications. The integral Lock-down assembly ensures the 50cm square modules, remain safe and secure under the heaviest of traffic.

Q-Tile's polymer base is simple to cut and shape and the modules are all interchangeable to ensure even wear for maximum economy. Q-Tile is 100% recyclable.

- » Cost effective
- » Easy to install

HOW TO ORDER

- » **PRODUCT RANGE:** Q-TILE
- » **THICKNESSES AVAILABLE:** 10 mm
- » **CONSTRUCTION:** CLOSED
- » **LOCATION:** INTERNAL
- » **COLOUR:** CHOOSE FROM COLOUR RANGE

PRODUCT INFORMATION

- » **GUARANTEE:** 5 YEARS
- » **VOLUME OF TRAFFIC:** LIGHT
- » **TYPE OF TRAFFIC:** MEDIUM
- » **SUGGESTED APPLICATIONS:**
OFFICES / SCHOOLS
- » **USAGE:** PRIMARY BARRIER MATTING

COLOUR RANGE

INTERNAL – Tufted Nylon



Other colours available on request.

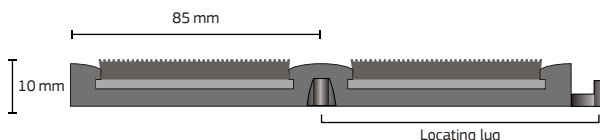

SPECIFICATION STATEMENT

NBS Specification :

N10 GENERAL FIXTURES / FURNISHINGS / EQUIPMENT
300 ENTRANCE MATTING / 40 MISCELLANEOUS FITTINGS

Manufacturer:

Quantum Flooring, QPSL, Salmon Fields, Royton, Oldham, OL2 6JG
Tel: 0161 627 4222 Email: info@quantumflooring.co.uk
Website: www.quantumflooring.co.uk

Reference: Q-Tile 50 cm Matting Tile

Construction: Closed construction, Single wiper, 10 mm height

Linking strip material: PVC

Wiper colour: See colour range

Fixing:

Recessed in matwell or surface-mounted with ramping frame

Q-CLICK 25 CM ENTRANCE MATTING TILE

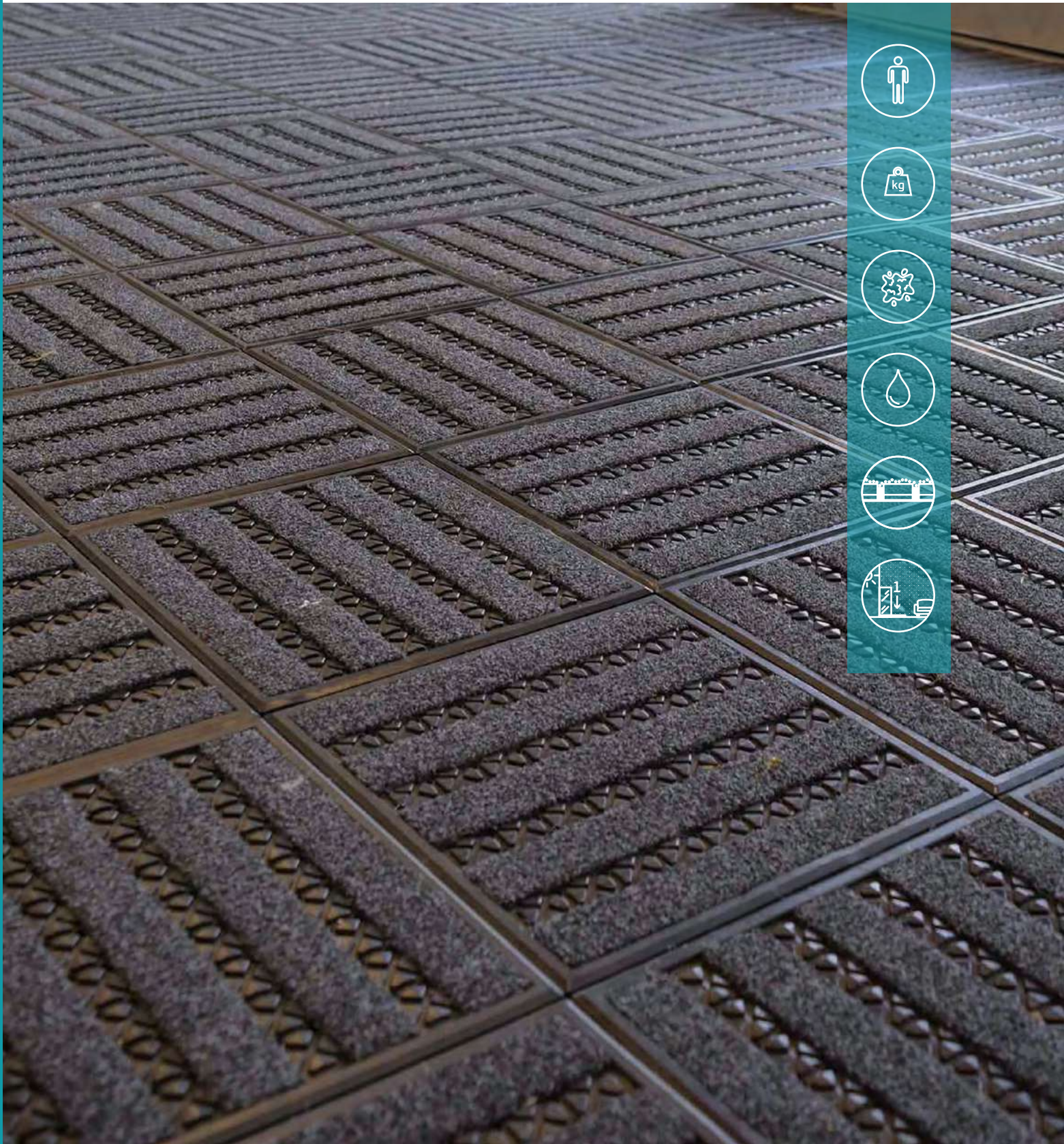

Q-CLICK 25 CM ENTRANCE MATTING TILE



Q-Click is the flexible solution to many entranceway matting requirements. This robust system gives a choice of tufted nylon or fibre rib wiper strips with integrally moulded alternating vinyl rib scraper bars. The convenient modules simply clip together to form a secure assembly. If required the matting may be trimmed to shape with a craft knife. The system provides an 'off the shelf' solution that any floor-layer can install. The economical Q-Click can be lifted, re-arranged and re-installed for even wear distribution. With a nominal thickness of 12 mm the product can be used for recessed or flat to floor applications.

- » Cost effective
- » Easy to install

HOW TO ORDER

- » **PRODUCT RANGE:** Q-CLICK
- » **THICKNESSES AVAILABLE:** 12 mm
- » **CONSTRUCTION:** CLOSED
- » **LOCATION:** INTERNAL
- » **COLOUR:** CHOOSE FROM COLOUR RANGE

PRODUCT INFORMATION

- » **GUARANTEE:** 5 YEARS
- » **VOLUME OF TRAFFIC:** LIGHT
- » **TYPE OF TRAFFIC:** MEDIUM
- » **SUGGESTED APPLICATIONS:**
OFFICES / SCHOOLS
- » **USAGE:** PRIMARY BARRIER MATTING

COLOUR RANGE

INTERNAL – Tufted Nylon

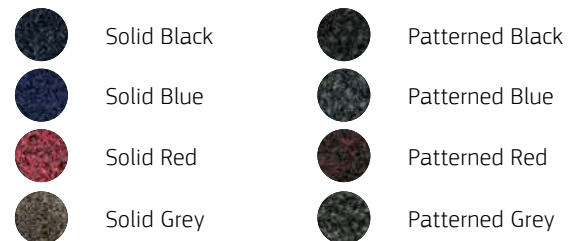

Other colours available on request.

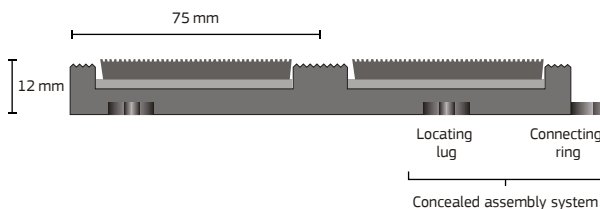

SPECIFICATION STATEMENT

NBS Specification :

N10 GENERAL FIXTURES / FURNISHINGS / EQUIPMENT
300 ENTRANCE MATTING / 40 MISCELLANEOUS FITTINGS

Manufacturer:

Quantum Flooring, QPSL, Salmon Fields, Royton, Oldham, OL2 6JG
Tel: 0161 627 4222 Email: info@quantumflooring.co.uk
Website: www.quantumflooring.co.uk

Reference: Q-Click 25 mm Matting Tile

Construction: Closed construction, 12 mm height

Linking strip material: PVC

Wiper colour: See colour range

Fixing:

Recessed in matwell or surface-mounted with ramping frame

Q-SECONDARY MATTING

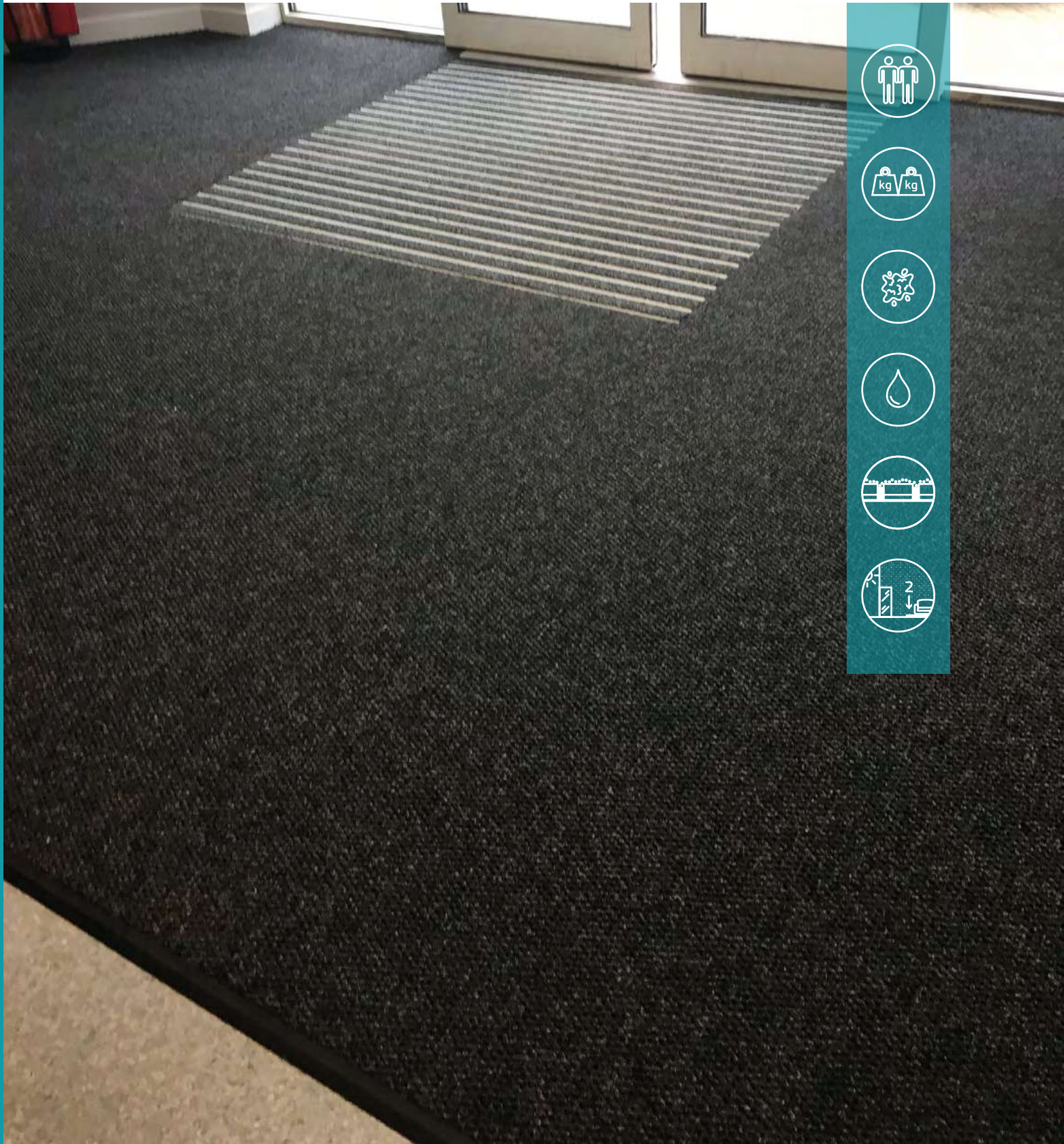

Q-SECONDARY MATTING

Q-Secondary Matting has an active, deep open pile to capture maximum moisture and debris between cleaning sessions. Developed from specially engineered coarse scraper fibre with fine fibre supplement for added absorbency.

Q-Secondary Matting is the ideal replacement for coir matting and is available in a variety of colours.

HOW TO ORDER

- » **PRODUCT RANGE:** SECONDARY MATTING
- » **THICKNESSES AVAILABLE:** 9mm
- » **COLOUR:** CHOOSE FROM COLOUR RANGE
- » **SIZE:** CUTS or ROLLS

PRODUCT INFORMATION

- » **VOLUME OF TRAFFIC:** MEDIUM
- » **TYPE OF TRAFFIC:** MEDIUM
- » **SUGGESTED APPLICATIONS:**
OFFICES / APARTMENT BLOCKS
- » **USAGE:** SECONDARY BARRIER MATTING

COLOUR RANGE

INTERNAL – Tufted Nylon

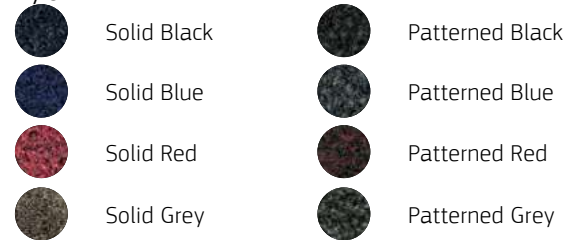

Other colours available on request.

SPECIFICATION STATEMENT

NBS Specification :

N10 GENERAL FIXTURES / FURNISHINGS / EQUIPMENT
300 ENTRANCE MATTING / 40 MISCELLANEOUS FITTINGS

Manufacturer:

Quantum Flooring, QPSL, Salmon Fields, Royton, Oldham, OL2 6JG
Tel: 0161 627 4222 Email: info@quantumflooring.co.uk
Website: www.quantumflooring.co.uk

Reference: Q-Secondary Matting

Construction: Secondary matting

Linking strip material: n/a

Wiper colour: See colour range

Fixing:

Recessed in matwell or surface-mounted with ramping frame

MATTING ACCESSORIES

Quantum Flooring matwell frames and ramping strips provide a neat and safe transition between the matting and the surrounding floor finish. Profiles are available to suit all gauges either in stock lengths or cut and mitred to specific dimensions. Please specify dimension required to either outside or inside of frame. For special shape requirements solid frame sections can be supplied formed to template. Alternatively formable framing is available to accommodate on-site shaping.

RAMP SECTIONS

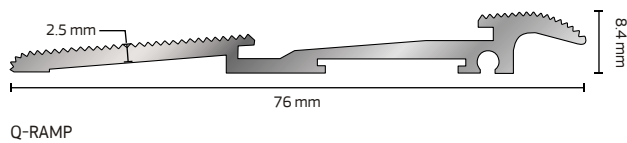

MATWELL FRAMES

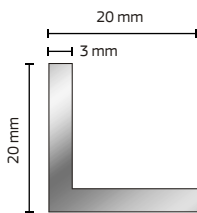

QM5A (Aluminium)
QM5S (Stainless Steel)

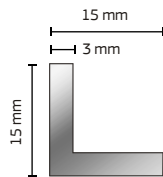

QM6A (Aluminium)
QM6S (Stainless Steel)

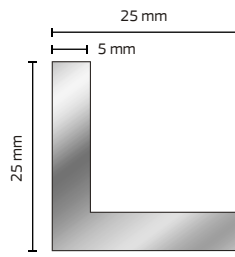

QM3A (Aluminium)
QM3B (Brass)

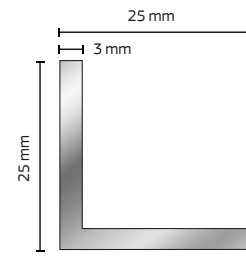

QM4A (Aluminium)
QM4S (Stainless Steel)

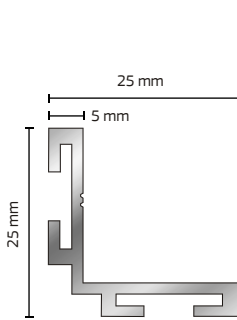

QM1A (Aluminium)

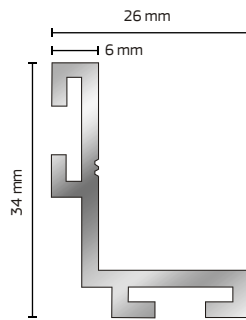

QM2A (Aluminium)

'T' SECTIONS

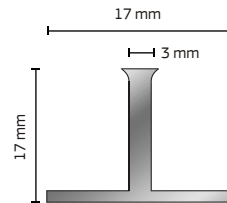

QMT17A (Aluminium)
QMT17B (Brass)

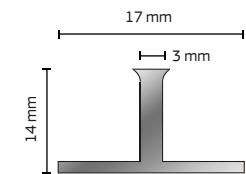

QMT14A (Aluminium)

FORMABLE FRAMES

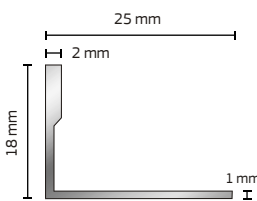

QMF18A (Aluminium)
QMF18B (Brass)

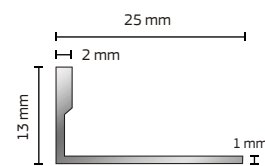

QMF13A (Aluminium)
QMF13B (Brass)
QMF13S (Stainless Steel)

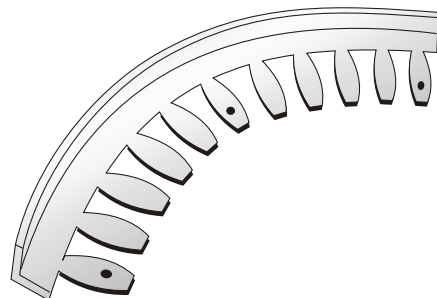

HOW MUCH MATTING IS REQUIRED?

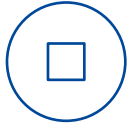

Light = 3–4 metres – less than 80 people per hour

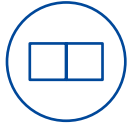

Medium = 6–7 metres – less than 500 people per hour

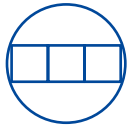

Heavy = 8–12 metres – over 500 people per hour

PLEASE NOTE: Building on guidelines from the HSL and EFSA, Quantum Flooring Solutions recommends that the length of matting should be based on the number of people entering a premises per hour. It is not always possible to achieve the required amount of matting, however, having some matting is better than not having any, if the space available is small.

INSTALLATION

Subfloor should be clean, dry and flat and prepared in accordance with BS 5325. Timber floors should be overlaid with marine ply or other suitable sheet material. Always ensure that the material is acclimatised to required site conditions for 24 hours prior to fixing with approved adhesives available from most leading contract flooring adhesive suppliers. Fixing by tape product is not recommended.

For more information visit quantumflooring.co.uk or call our customer care team on 0161 627 4222.

CLEANING & MAINTENANCE

In order to obtain the highest efficiency in performance, all of the soil and debris collected by the matting must be removed, on a regular basis, with a cylinder brush driven vacuum cleaner or similar. UKM Cleaning and Maintenance manual is available on request. BS 7953 'Entrance Flooring Systems' - Selection, Installation and Maintenance provides further information if required.

For more information visit quantumflooring.co.uk or call our customer care team on 0161 627 4222.

TOPCLIP

The TopClip range from Quantum Flooring Solutions is a two-piece product suitable for use in all commercial and public situations (including hospitals and schools). TopClip can now fit across an even greater range of height differences at floorcovering joints, due to the redesigned clip-in top profiles which are securely accepted into the base sections. TopClip can now form a neat, safe and durable junction between practically any variation of different floorcoverings. The slip resistant Tops are available in 24 colours to complement any design scheme and are easy to clip-in and fit on site, plus uPVC bases can also be curved on-site.

SELF-LEVELLING SYSTEM

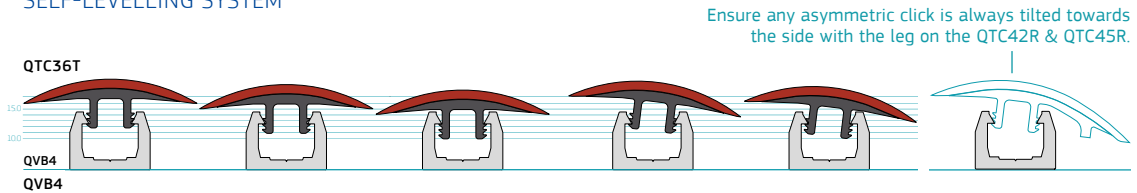

PRODUCT COMBINATIONS

	QTC36T	QTC42R	QTC45R	QTC60R
QVB2	18 ——— 13-14 14-16 ——— 14-16	17-18 ——— 10-11 13-15 ——— 11-13	17-18 ——— 7-8 15-17 ——— 8-10	15-19 ——— n/a 3-7
QVB4	14 ——— 10-11 11-13 ——— 14-16	14-15 ——— 5-7 10-12 ——— 6-8	14-15 ——— 2-3 12-14 ——— 4-6	14-16 ——— n/a 0-3
QVB1	10 ——— 7-8 8-9 ——— 8-9	10 ——— 0-3 7-9 ——— 2-4	12 ——— 0 10-12 ——— 0-2	n/a n/a
QVB3	8-9 ——— 5-6 6-7 ——— 6-7	8-9 ——— 0-1 6-8 ——— 2-4	10-11 ——— n/a 0-1	n/a n/a
QAB1	8 ——— 5 5-7 ——— 5-7	8 ——— 0 5-6 ——— 1-2	8 ——— n/a 0	n/a n/a
QAB2	9-10 ——— 7-9 8-10 ——— 8-10	8-9 ——— 0-1 7-9 ——— 2-4	10-11 ——— n/a 0-1	n/a n/a

SITE MEASURE SERVICE



Save time and money with Quantum Flooring Solutions' free Entrance Matting measuring service, QSMS:

Specially trained site surveyors can provide face to face advice when selecting the correct mat. The service includes measuring for the mat, ensuring that the product selected is matched to the exact requirements of the building and when delivered, it fits in the available matwell space.

SUPPLY & FIT SERVICE



Have peace of mind by using Quantum Flooring Solutions' complete service:

Quantum Flooring offers a full supply and fit service, ensuring a simple and reliable service throughout the specification process all the way to installation. All types of installation, including the most complex mat designs, can be undertaken by expert installation teams.

COLOUR RANGE

Q-GUARD

INTERNAL – Rubber Nylon



Q-GUARD, Q-GRID, Q-CONNECT

EXTERNAL – Rubber Rib

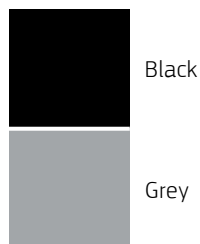

Q-GRID, Q-CONNECT, Q-TILE, Q-CLICK, Q-SECONDARY

INTERNAL – Tufted Nylon

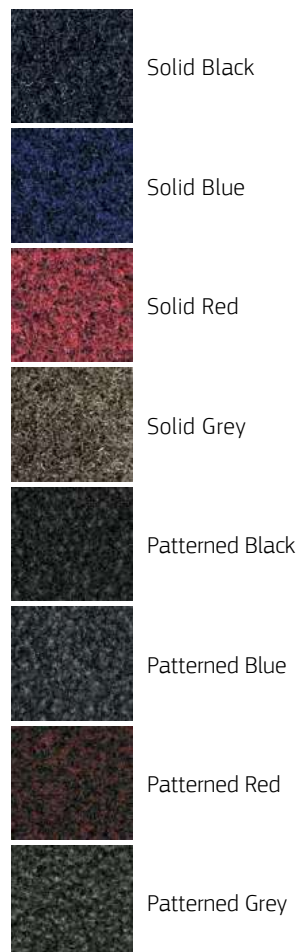

Q-FIBRE

INTERNAL – Needle-punch fibre bonded rib



RIBA CPD



RIBA approved CPD seminar:

'STEP ON IT!' SPECIFICATION OF ENTRANCE MATTING

A presentation and discussion dealing with the subject of specifying safe and effective entrance matting. The CPD presentation includes:

- » What entrance matting is designed to achieve and how to select the right one.
- » How recent BRE, BS and Equality Act guidelines affect the choices for specifiers.
- » Environmental and health and safety considerations applicable to the manufacture, installation and maintenance of entrance matting.
- » Examples of best practice with specification examples.

Handouts include reference links to further information and the seminar lasts 40–60 minutes including time for a Q&A session.



RIBA ROAD SHOW



Lunch & Learn:

If a formal CPD is not for you, why not book a 'Lunch & Learn' session with us.

We'll come to your office with a lovely buffet lunch and be available to answer any questions you have regards the specification on entrance matting in a casual informal setting.



OTHER PRODUCTS FROM QUANTUM FLOORING SOLUTIONS



STAIR NOSINGS



TRANSITIONS



ACCESSORIES



ADHESIVE

Visit
quantumflooring.co.uk
or call
0161 627 4222

- STAIR NOSINGS
- ACCESSORIES
- TRANSITIONS & ENTRANCE MATTING

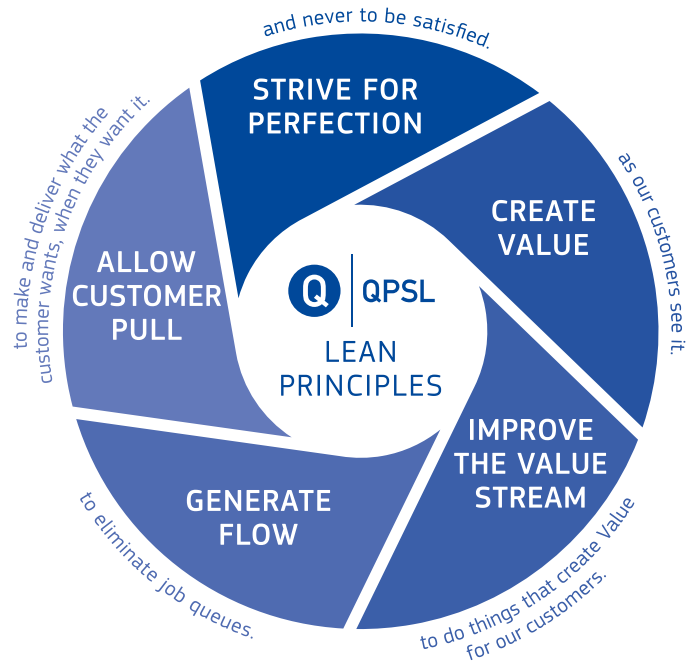

FOR SALES & TECHNICAL SUPPORT CALL:

+44 (0) 161 627 4222



Quantum Profile Systems Ltd
Salmon Fields, Royton, Oldham, OL2 6JG, UK

tel: +44 (0) 161 627 4222 fax: +44 (0) 161 627 4333

[@QuantumFlooring](#) info@quantumflooring.co.uk quantumflooring.co.uk



PART OF QPSL LEAN, GREEN, SAFE & CLEAN

At QPSL we strive for continuous improvement in our environmental, health and safety management systems and in the environmental quality of our products, processes and services.

Details correct at time of publication but please visit the website for the latest product information.